

ZUBNÍ ORDINACE Bruntál | Ordinace 1

POHLED 01

| 1:15/A3

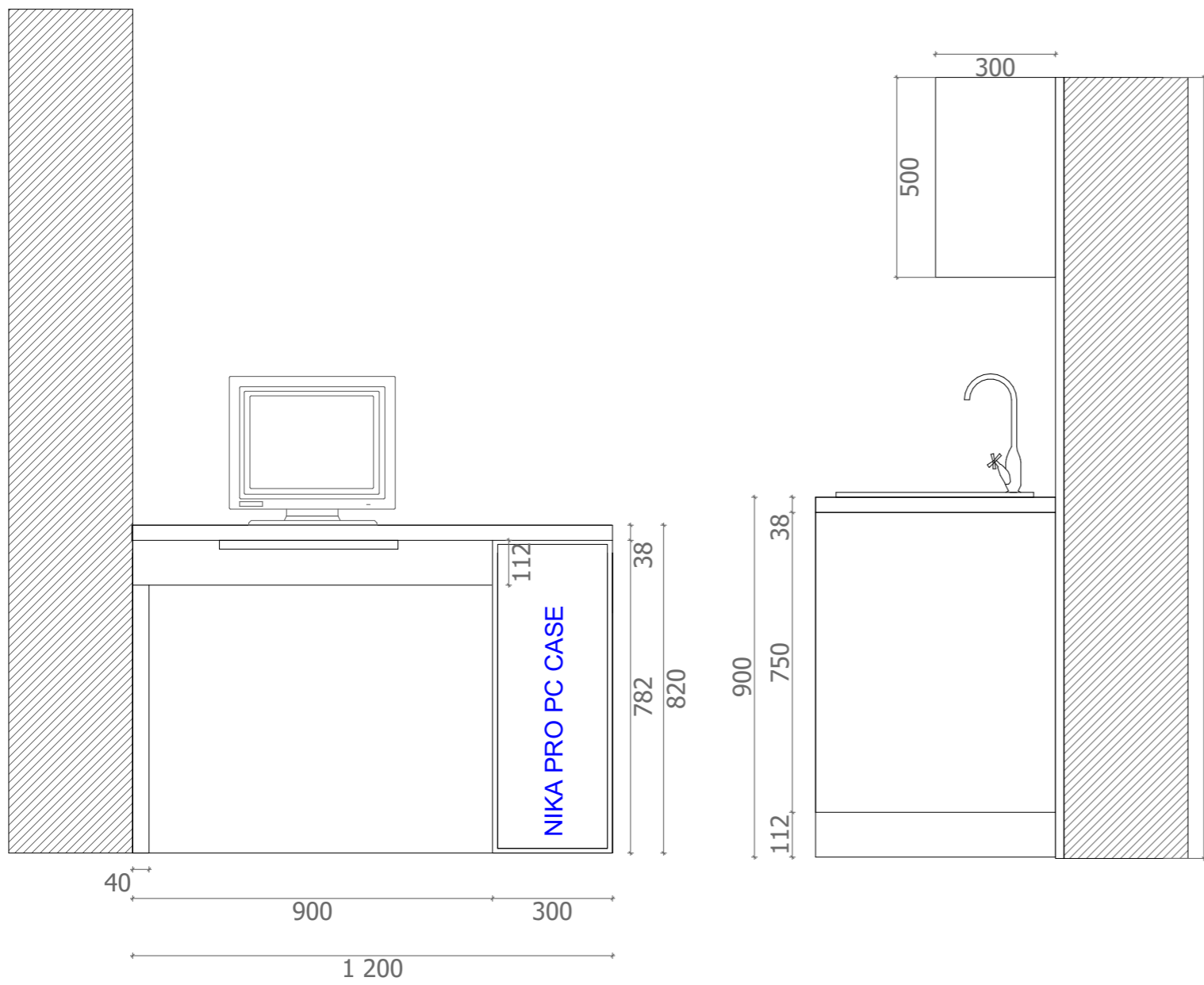

POHLED 02

| 1:15/A3

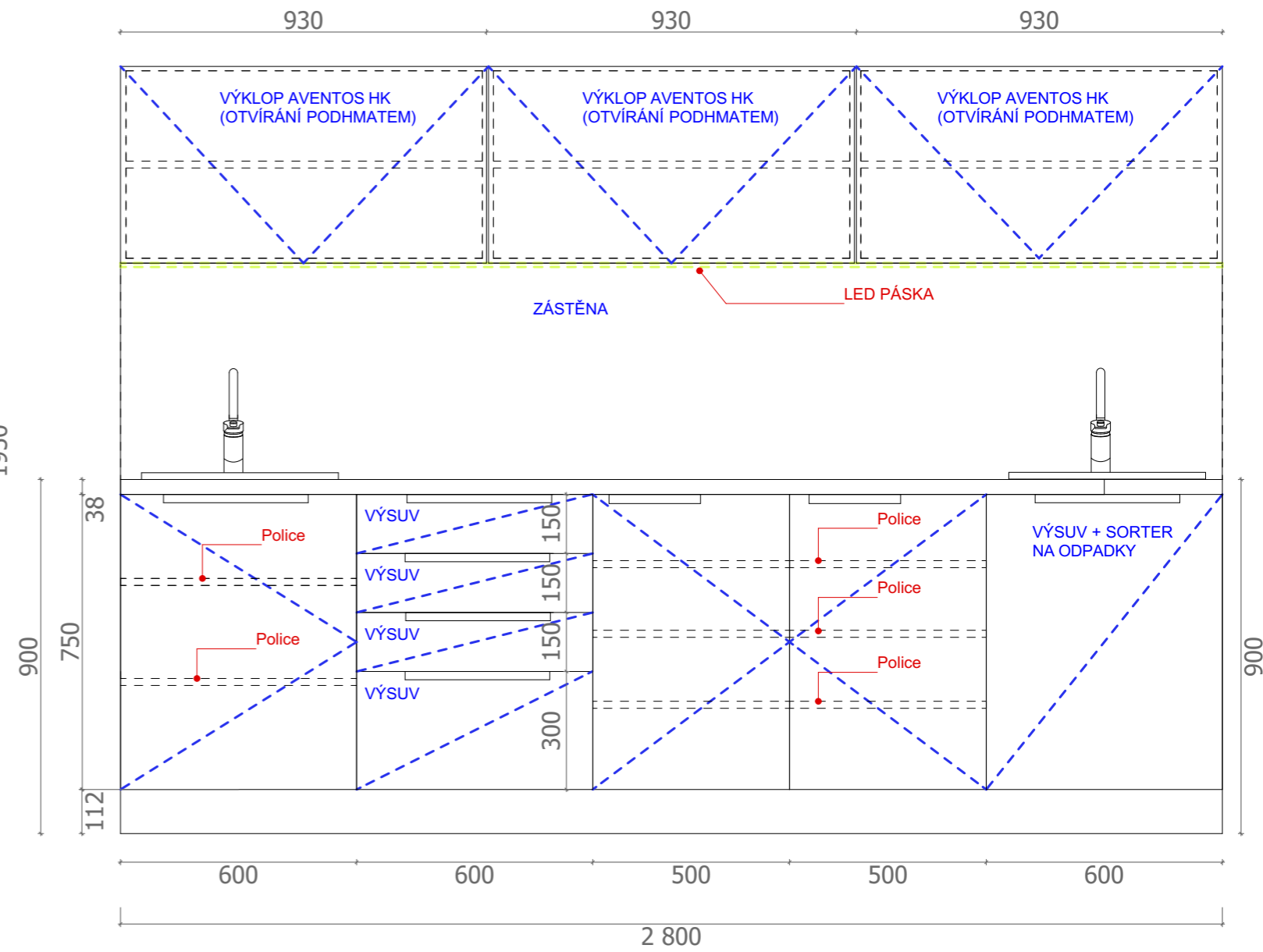

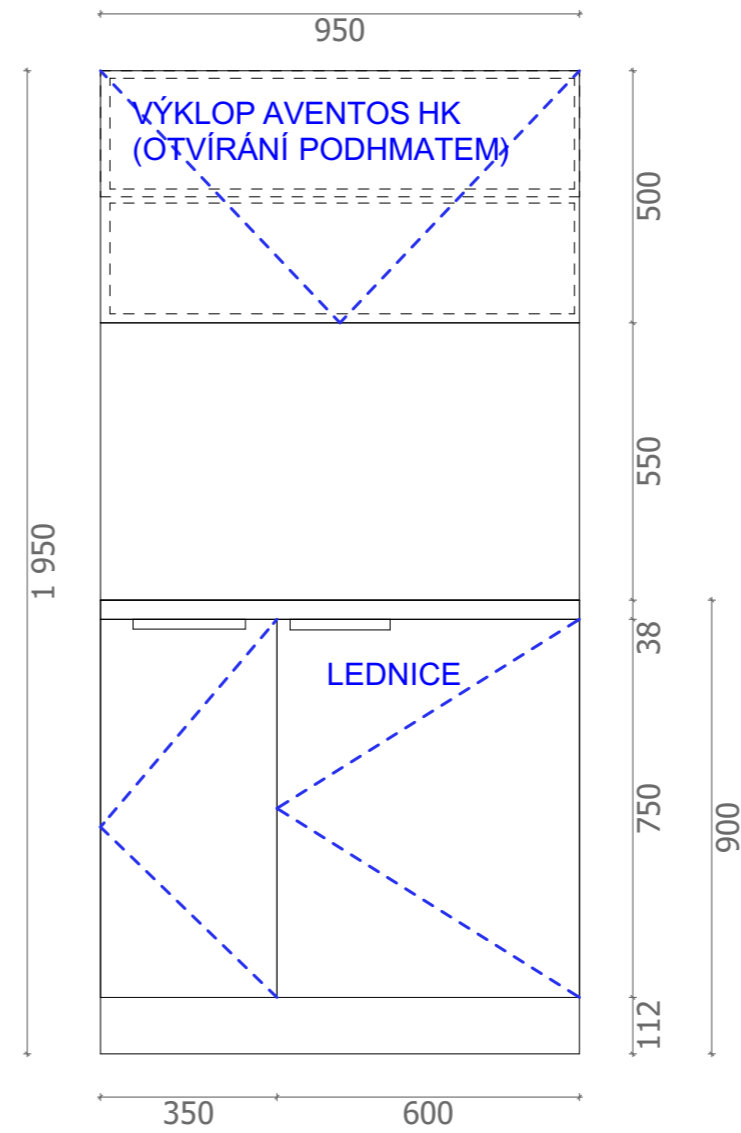
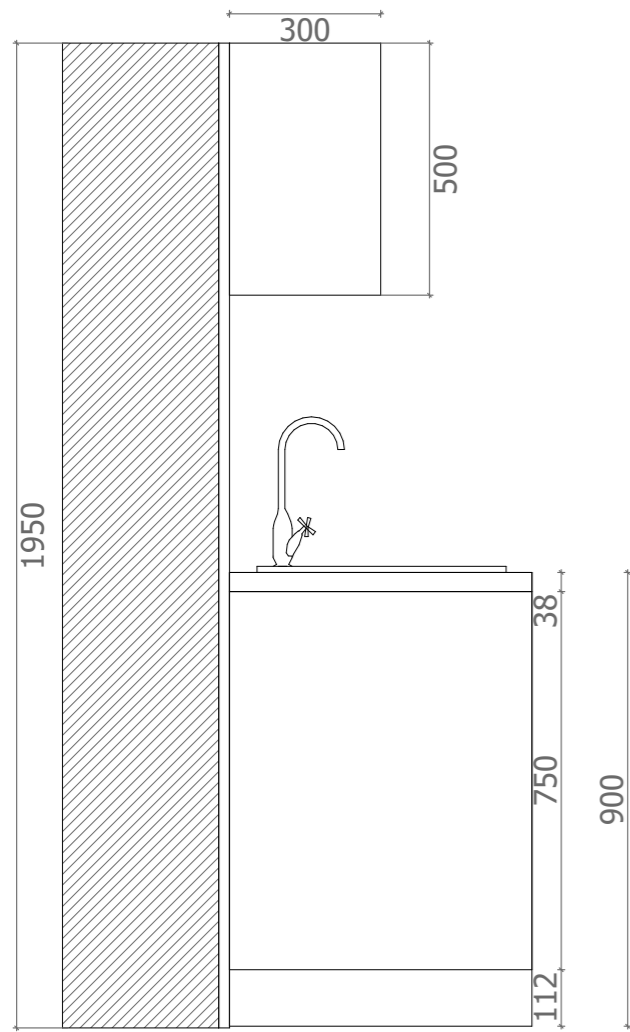

ZUBNÍ ORDINACE Bruntál | Ordinace 2

POHLED 01

| 1:15/A3

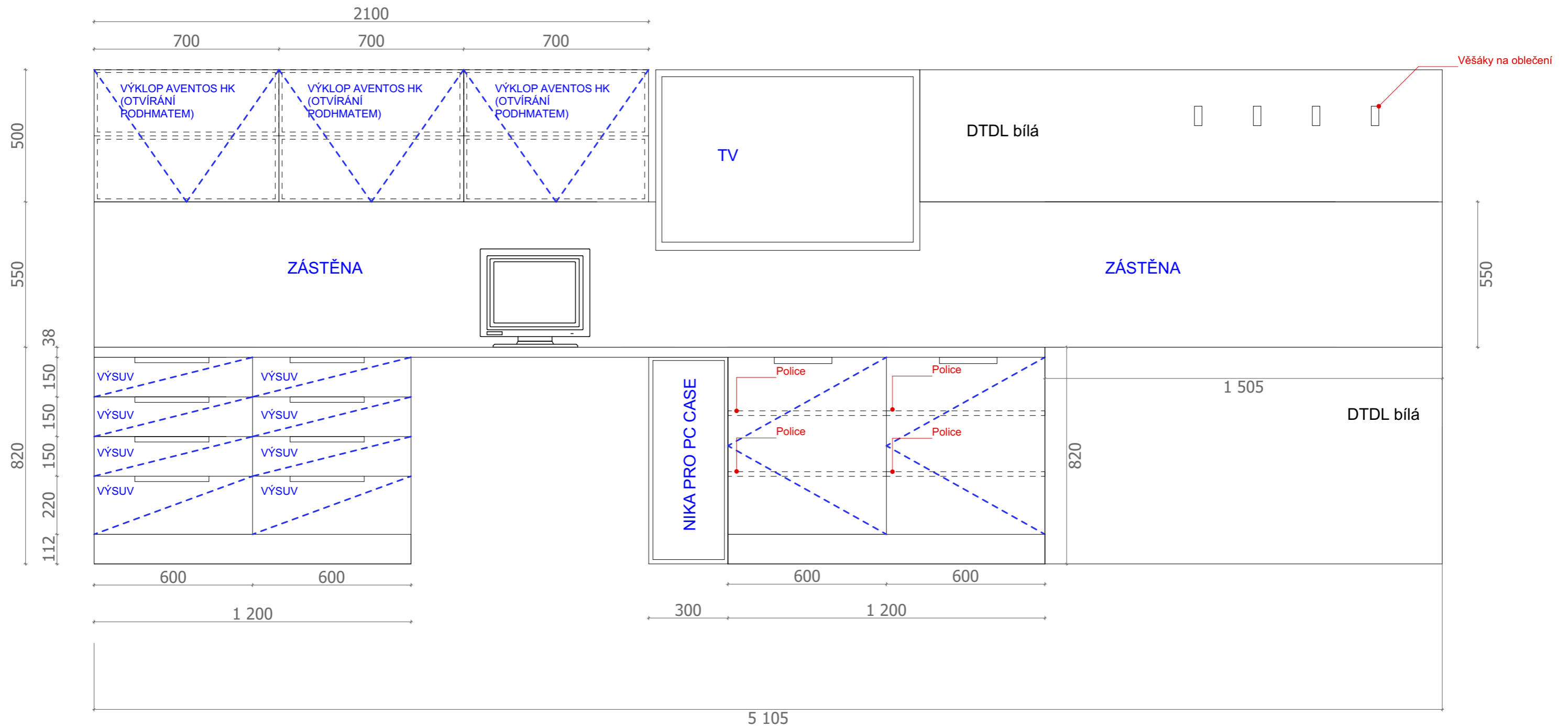

ZUBNÍ ORDINACE Bruntál | Ordinace 2

POHLED 03

| 1:15/A3

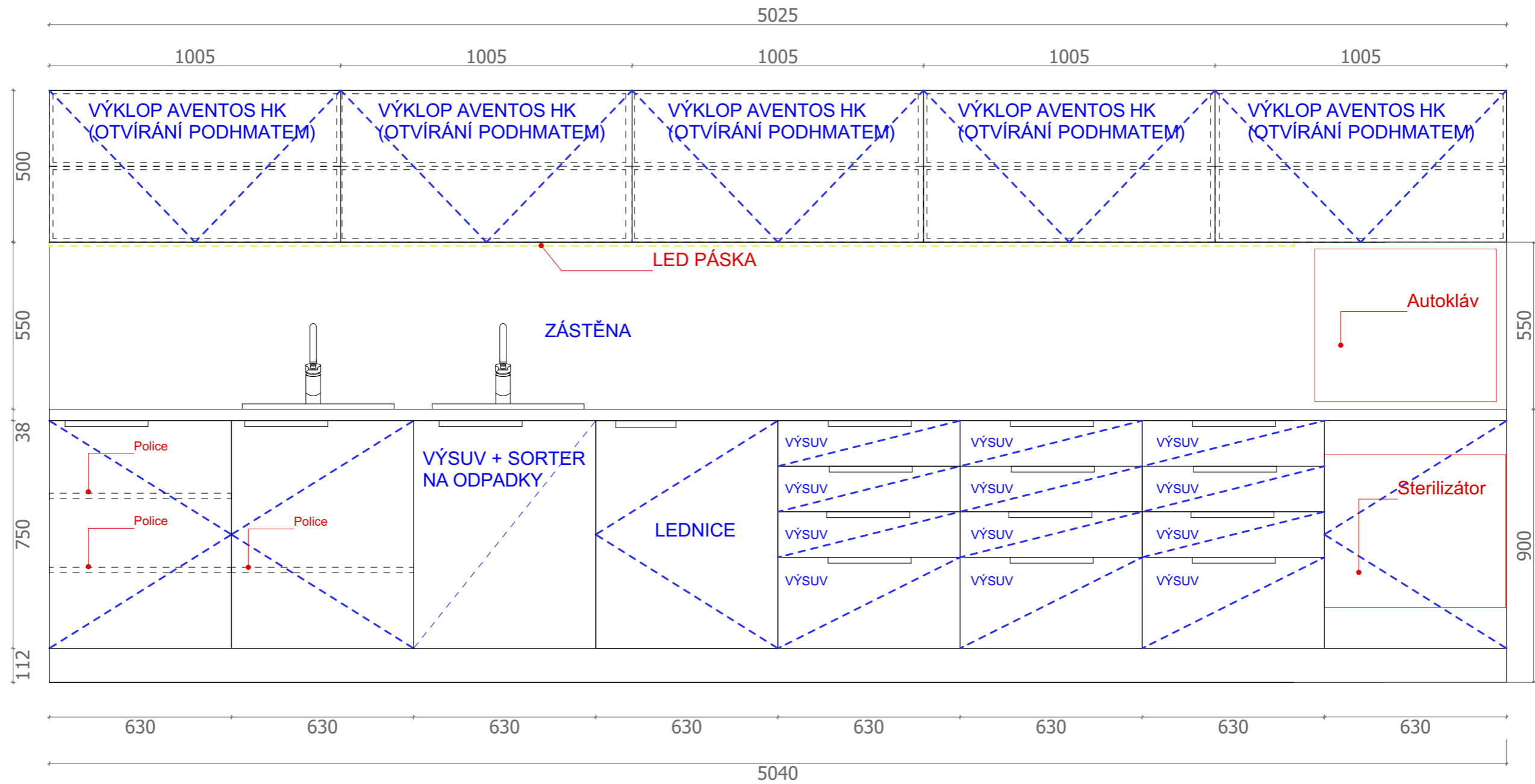

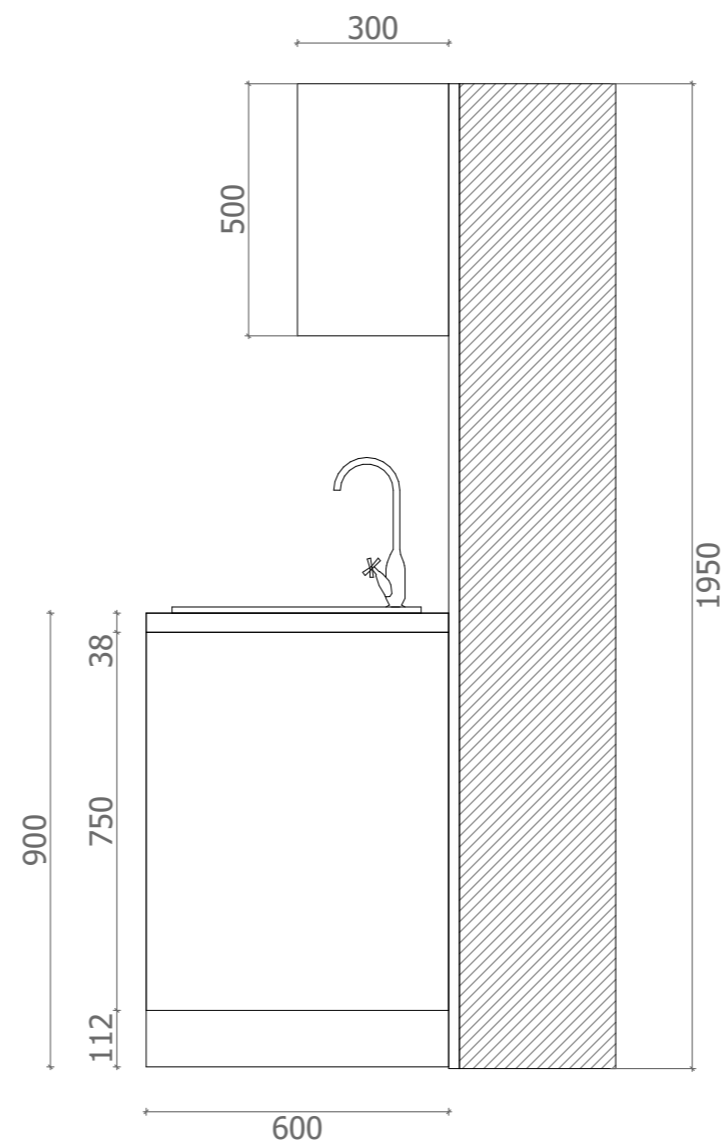
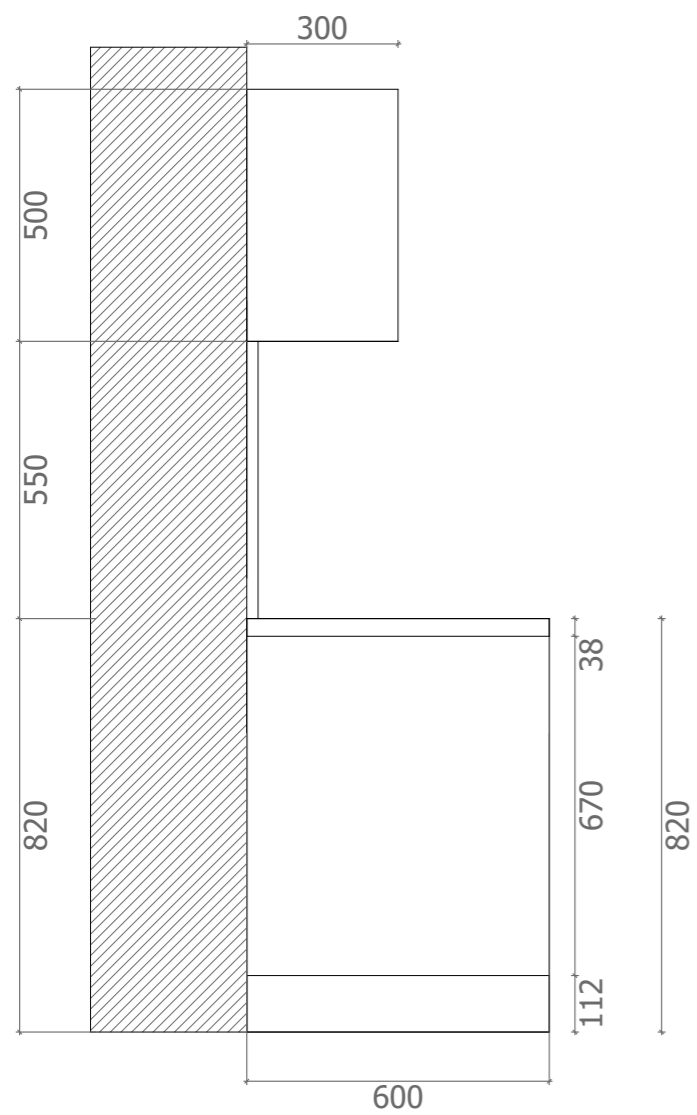

ZUBNÍ ORDINACE Bruntál | Recepce č.3

PUDORYS

| 1:20/A3

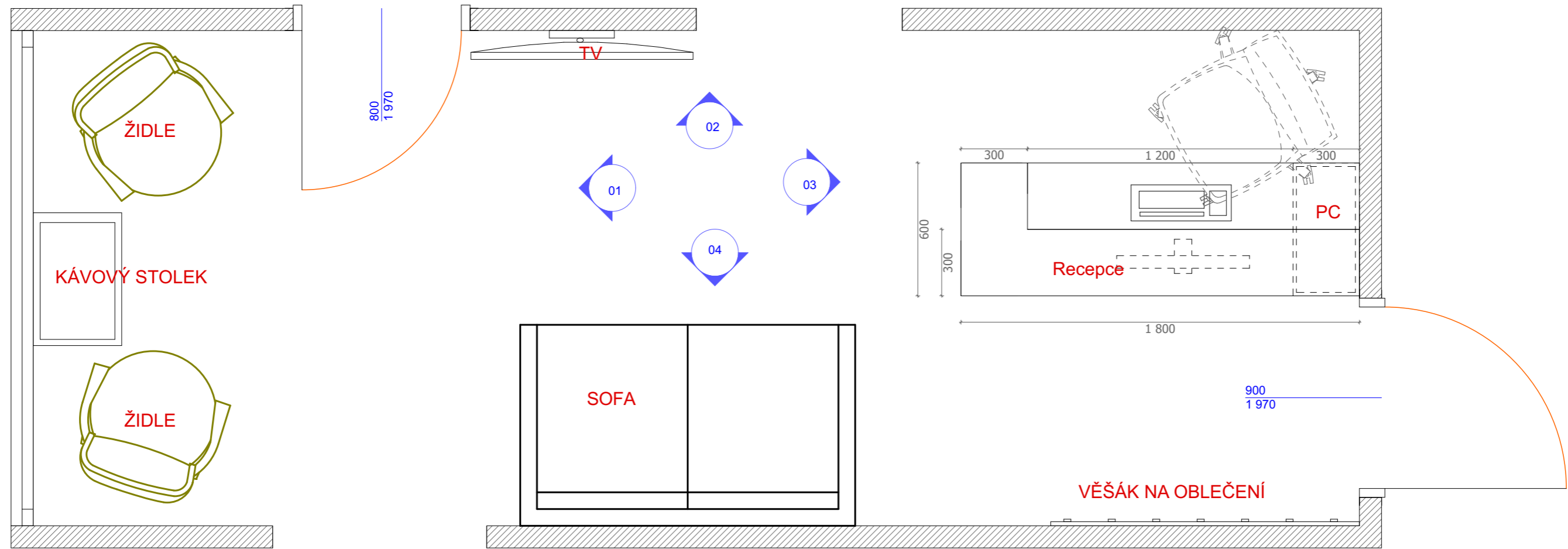

ZUBNÍ ORDINACE Bruntál | Recepce č.3

POHLED 01

| 1:10/A3

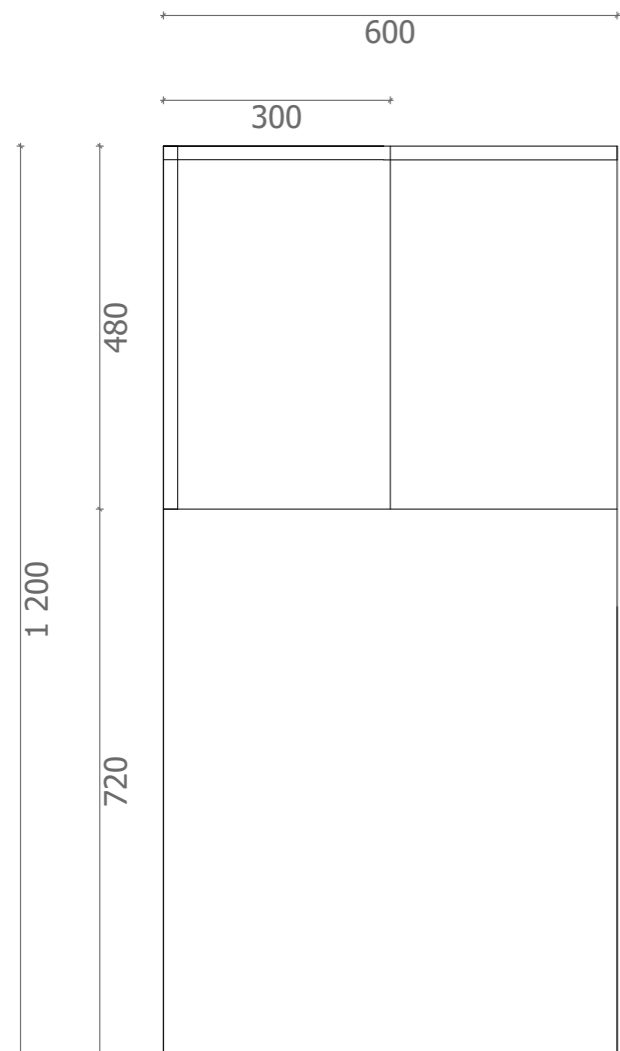

POHLED 02

| 1:10/A3

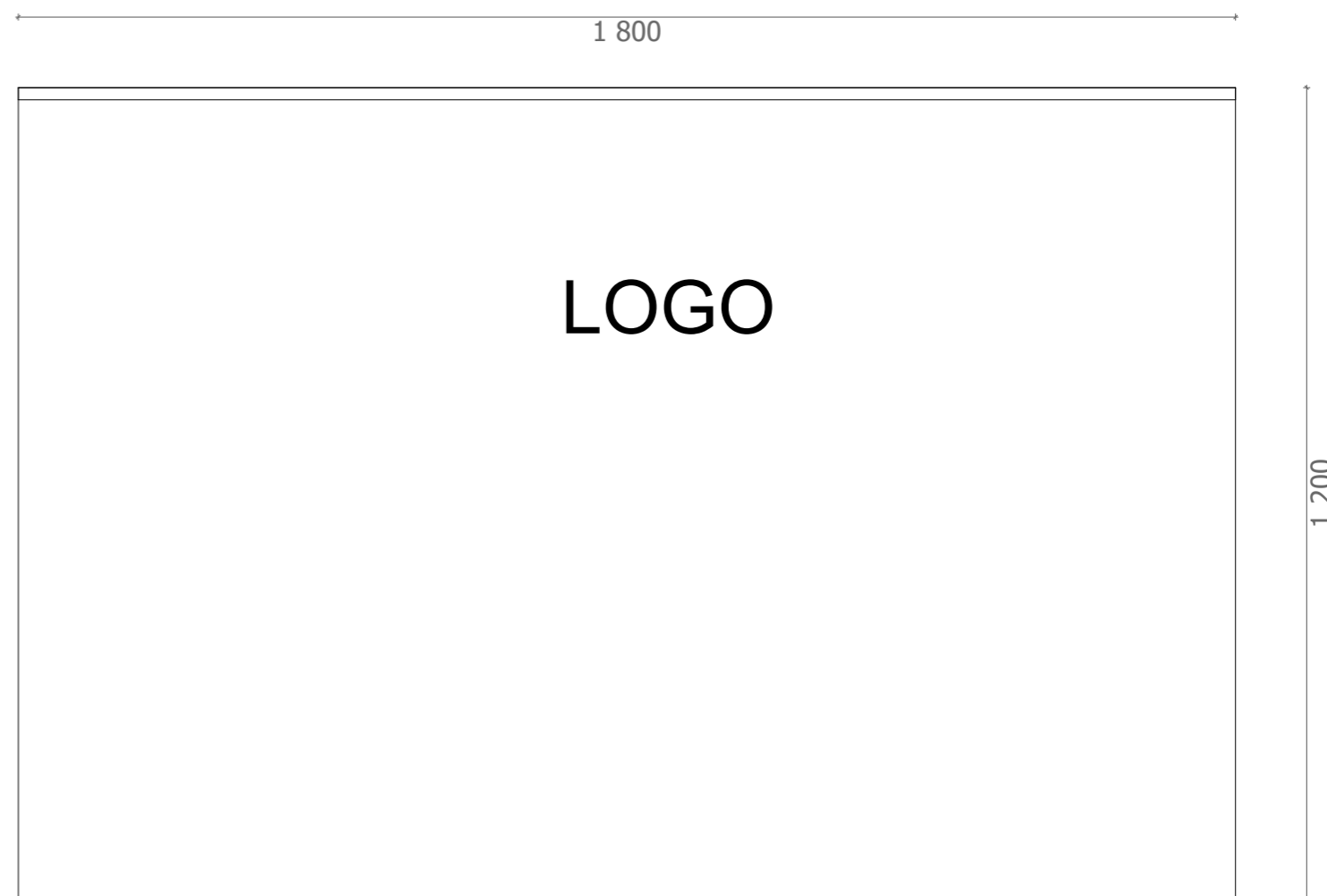

ZUBNÍ ORDINACE Bruntál | Recepce č.3

POHLED 03

| 1:10/A3

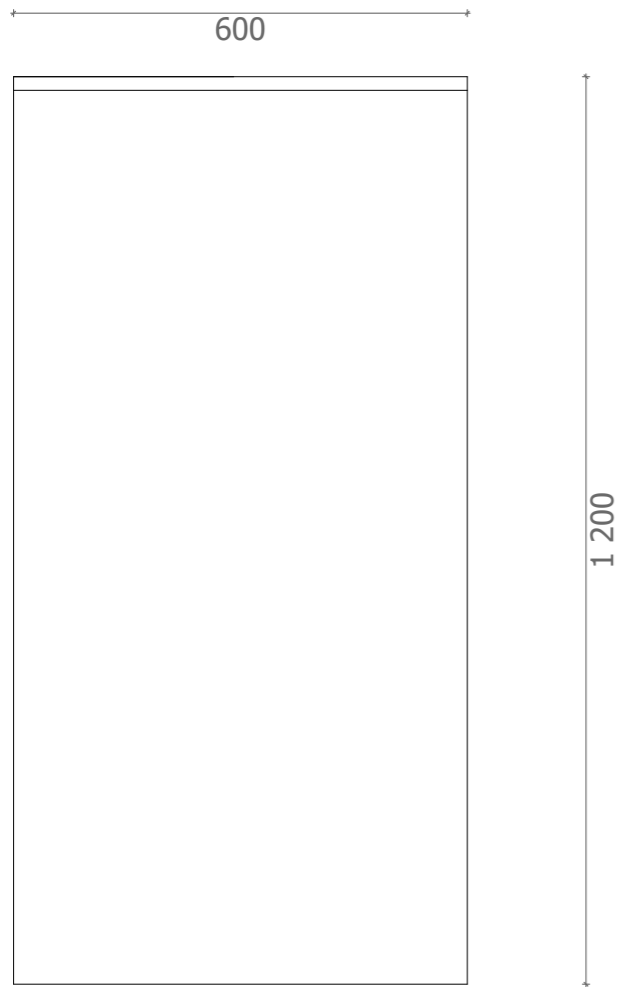

POHLED 04

| 1:10/A3

